

# CAROUSEL

KENETHCOBONPUE



HANGING LAMP

🏠 cotton rope,  
powder-coated steel

## HANGING LAMP, large

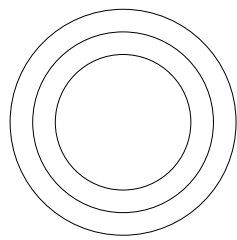

100 cm  
39 1/2"

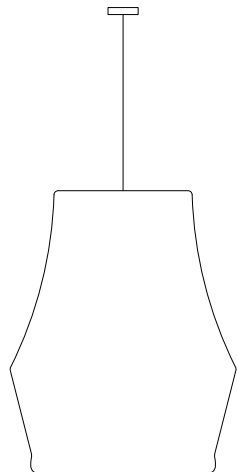

150 cm  
59"  
120 cm  
47 1/4"

 9 kg / 20 lbs

 14.60 kg / 32 lbs

 0.232 m<sup>3</sup>

1 x 100 watts

Surface mounted pre-wired lamp

E26 / E27

110V 60Hz / 230V 50Hz

## INDOOR cotton rope, powder-coated steel

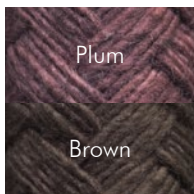

LCL-PB-3947

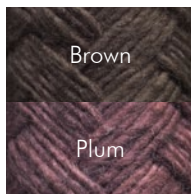

LCL-BP-3947

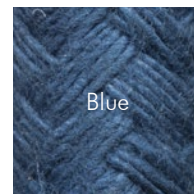

LCL-BU-3947



LCL-PO-3947

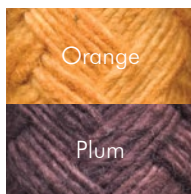

LCL-OP-3947



LCL-LGG-3947

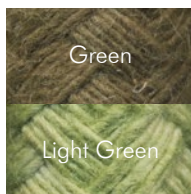

LCL-GLG-3947

## HANGING LAMP, medium

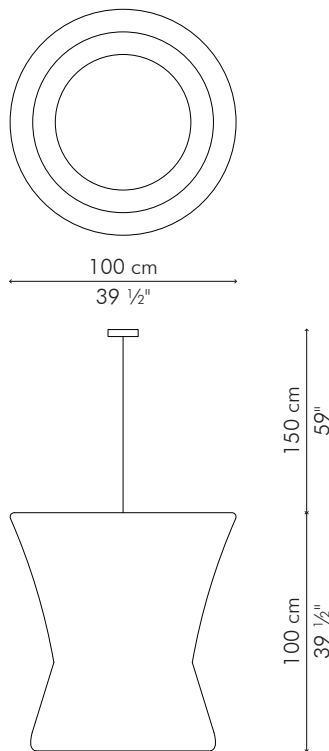

 7.60 kg / 17 lbs

 12.60 kg / 28 lbs

 0.221 m<sup>3</sup>

1 x 100 watts

Surface mounted pre-wired lamp

E26 / E27

110V 60Hz / 230V 50Hz

## INDOOR cotton rope, powder-coated steel

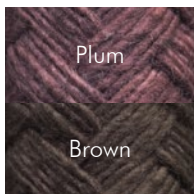

LCL-PB-3939

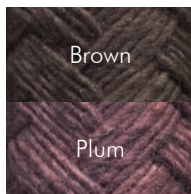

LCL-BP-3939

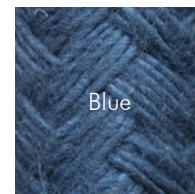

LCL-BU-3939



LCL-PO-3939

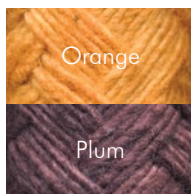

LCL-OP-3939

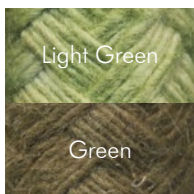

LCL-LGG-3939

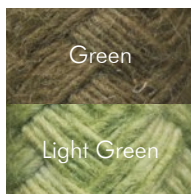

LCL-GLG-3939

## HANGING LAMP, small

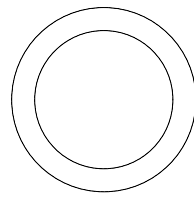

80 cm  
31 1/2"

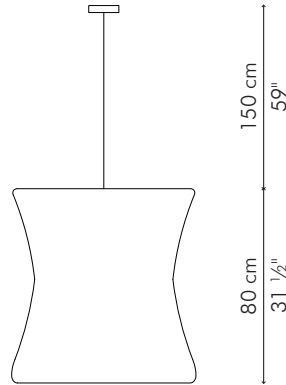

150 cm  
59"

80 cm  
31 1/2"

 5.50 kg / 12 lbs

 9 kg / 20 lbs

 0.145 m<sup>3</sup>

1 x 100 watts

Surface mounted pre-wired lamp

E26 / E27

110V 60Hz / 230V 50Hz

## INDOOR cotton rope, powder-coated steel

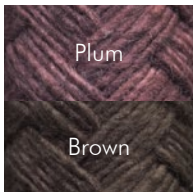

LCL-PB-3131

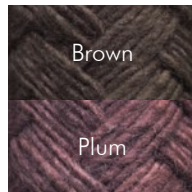

LCL-BP-3131

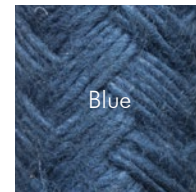

LCL-BU-3131



LCL-PO-3131

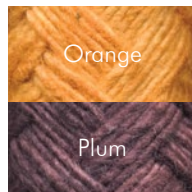

LCL-OP-3131



LCL-LGG-3131

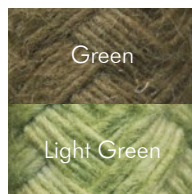

LCL-GLG-3131